

**THETFORD**



# Hob-grill Mini Grill 720-730 Series

Installation Manual

# EN

## Original Installation Manual

## Contents

1	Introduction.....	2
2	Symbols.....	2
3	Regulations and standards.....	3
4	Serviceability.....	4
5	Before installation.....	4
6	Position and placement.....	4
7	Connecting gas.....	8
8	Connecting electricity.....	8
9	After installation.....	9
10	Technical specifications.....	10
11	Servicing.....	11
12	Questions / customer service.....	11

## 1. Introduction

This is the installation manual for the Thetford SHG720 and SHG730 series mini-grill. The manual is meant for qualified installers who will install the mini-grill in a caravan, camper, boat or holiday home. Read the information and instructions carefully and follow them strictly to install the mini-grill safely and correctly.

Also read the warnings in the user manual before testing the mini-grill after installation.

Our policy is one of continuous development and improvement. Specifications and illustrations may change subsequent to publication.



If the appliance is not installed in accordance with national and European regulations, rules and standards this will void the warranty and may lead to criminal prosecution.

## 2. Symbols

Key to symbols:



**Warning.** Risk of injury and/or damage.



**Attention.** Important information.



**Note.** Additional information.

### 3. Regulations and standards

EN



Do not modify this appliance, unless the modification is authorised and carried out by the manufacturer or their agent.



Use only genuine and approved parts and materials.



Wear the correct Personal Protective Equipment during the installation. Also follow the applicable safety regulations.



Gas and electrical appliances should only be installed by qualified and certified professionals.



Ensure that the type of gas and pressure match the specification of the appliance. You can find the specification on the data badge.



Pay close attention to current regulations on ventilation in the country of use. The installation must provide for adequate air supply for combustion to the burners, safe removal of combustion products and avoidance of accumulation of unburned gases.



If it is not possible to install the appliance in accordance with these instructions, please refer to Thetford for further guidance.



For more information about ventilation regulations and requirements, see Position and placement.

## 4. Serviceability

The installer of Thetford products is responsible for proper installation to ensure the correct functionality and serviceability of the appliance. In terms of serviceability, this means that a dealer or an authorised Thetford service partner must be able to de-install and re-install the Thetford products within the time that is allowed according to the Thetford time-list, using standard tools and equipment.

This is to claim any warranty during the period of 3 years after purchase date. In case of any queries on this subject, please contact the Thetford local service representative before installing the product.

## 5. Before installation

Check the contents of the box:

- SHG720 or SHG730 series mini-grill
- Grill pan
- User manual
- Installation manual



If something is missing from the box, please contact your dealer.

## 6. Position and placement

- Remove all packaging materials from the appliance.
- Check the opening where the appliance will be installed. The location must provide:
  - Wood cabinetry
  - Support for weight of at least 30kg (for the mini-grill and items placed inside)
  - Grounded electrical outlet
  - Minimum installation clearances for installation location (see images below)
- Mount the wood battens to both sides of the cabinet.
- Slide the appliance all the way into the opening.

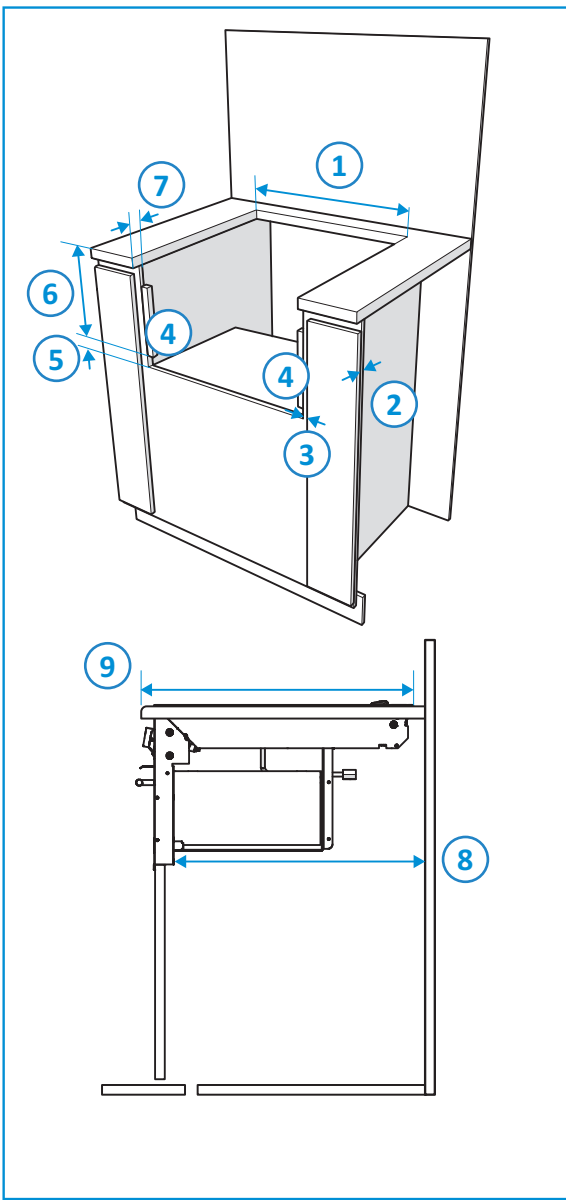

- 1. 496-498mm
- 2. 17mm
- 3. 10mm
- 4. Wood batten, max. 40x15x140mm, to be fitted to both sides of the cabinet
- 5. 40mm
- 6. 272mm
- 7. 37mm
- 8. 473mm
- 9. 493mm



The appliance must be positioned free from draughts, which may effect the combustion. It must also be positioned in a manner that will prevent the accumulation of unburnt gas.



This appliance may be installed in a kitchen/kitchen diner but not in a room containing a bath or a shower. LPG appliances must not be fitted below ground level e.g. in a basement.



Follow the minimum dimensions shown in this manual. Any deviation could result in excessive temperature rise. If the minimum dimensions must be reduced, due to design constraints, a temperature rise test of all furniture fitted around the appliance must be performed. Where the minimum dimensions are reduced, it is recommended to install non-combustible material.



The surrounding surfaces must be able to withstand the allowable temperature rise of 65°C above ambient temperature, as specified in the EN30-1-1 standard and in accordance with the design of this unit.



All combustible materials such as curtains and shelves must be kept well clear of the appliance.



The temperature of the surrounding surfaces may rise if there are other additional devices besides the appliance. Check the allowable temperature of the materials used for the surrounding surfaces to ensure that they meet the requirements of EN30-1-1, EN1949, EN1645-1, EN1646-1, EN1647 and EN721.

- Fix the appliance in place using the fixing screw positions located in the hob side trims and grill front trims. Make sure the appliance is located correctly in the aperture prior to final fixing.
- Maintain the minimum distances between the cooking appliance and side, rear and overhanging parts.

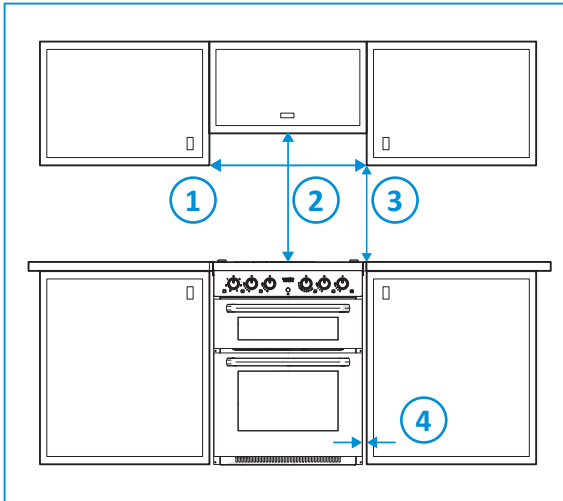

1. min. 500mm
2. min. 500mm
3. min. 400mm
4. min. 10mm

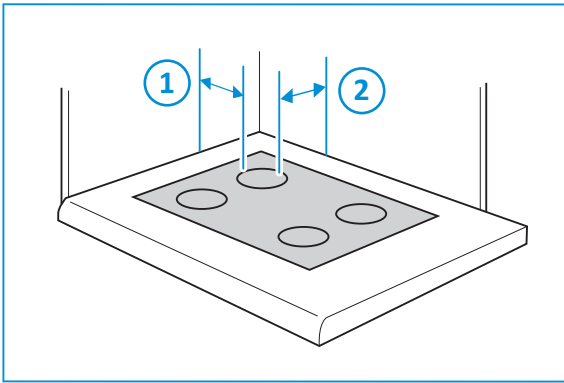

- 1. min. 200mm
- 2. min. 200mm



If you are unable to maintain these minimum distances, install fire-resistant material for protection.



For models with a glass lid, the distance from the edge of the burner to the rear wall can be reduced to 110mm.

- Provide venting to the outside [A].

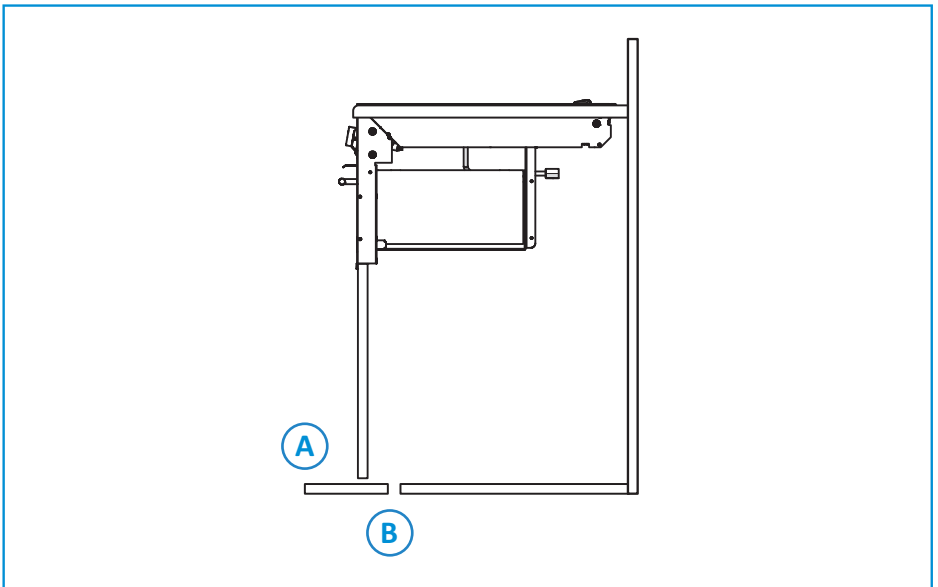

To ensure correct operation the installation must allow for free exchange of air between the enclosure and the living environment.



Design constraints may dictate additional venting at the front of the installation.



Maintain provision for the dispersal of unburnt gas beneath the appliance. Ensure any gas dispersal hole [B], is located away from the oven burner.



To ensure correct operation and prevent changes in air pressure affecting appliance performance, the appliance must be built into a securely fixed self-contained cabinet which is not connected to externally vented chambers in adjacent furniture, other than the gas dispersal hole described above.

## 7. Connecting gas

- Connect the gas to the Ø8mm gas inlet.
- Use only metal gas pipes in accordance with the requirements of EN1949.



Never use rubber tubing.



The burners have a fixed air/fuel mixture. When using propane, the flames burn quietly with a blue-green colour and no yellow at the tip. With butane, the flames have yellow tips. The yellow colour of the flames increases slightly as the burner heats up.

## 8. Connecting electricity

- Connect the spark ignition cables to a 12V DC battery using appropriate connectors.



Dual Fuel only:

- Models fitted with power cord only: This appliance is supplied with a double insulated cord, type 227 IEC 53, H05VV-F, which is suitable for use up to 4A. This should be connected to a double pole switched mains supply, with 3mm minimum contact separation at all poles in accordance with the wiring rules. The switch must be accessible after installation.
- Models fitted with Euro plug and power cord: This appliance is supplied with a Euro plug attached to the end of the power cord, for connection to a switched wall mounted socket. The switched socket must be accessible after installation.

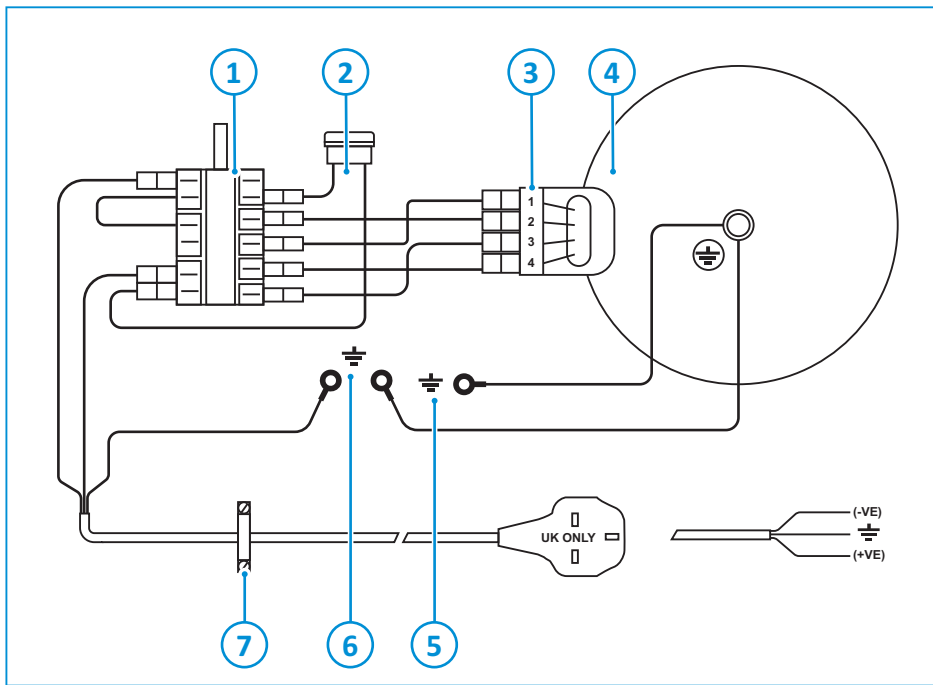



- 1. Rotary switch
- 2. Warning lamp
- 3. Hotplate numbers
- 4. Hotplate
- 5. Earth (hob)
- 6. Earth (fascia)
- 7. Cable clamp

-  This appliance must be earthed.
-  Ensure that all electrical cables are routed directly away and well clear of this appliance and other heat sources.
-  Do not allow the cord or wires to hang loose into the lower compartment.







## 9. After installation

- Ensure that all packaging materials have been removed.
- Fix a warning label next to the unit that meets the requirements of EN721, Annex A.
- Fix a warning notice next to the gas dispersal hole, with the text: Warning! Under no circumstances should the gas dispersal hole be obstructed.
- Test all gas piping and connections and make sure they do not leak.



- Check the pressure of the gas when all connected gas appliances are in use simultaneously. The gas pressure may not rise or fall by more than 2.5mbar relative to the nominal value.

## 10. Technical specifications

**Table 1: Burner specifications**

	SHG720 series				SHG720 series			
	Gas input		Injector		Gas input		Injector	
								
	kW	g/hr	mm		kW	g/hr	mm	
			Sabaf	Somi-press			Sabaf	Somi-press
Gas burners	3 x 1.5 1 x 1.0	3 x 108 1 x 72	0.62 0.50	0.61 0.52	2 x 1.5 1 x 2.5	2 x 108 1 x 180	0.62 0.78	0.61 0.77
Grill burner	1.6	115	0.62	0.62	1.6	115	0.62	0.62
Total	7.1	511			7.1	511		

	SHG730 series			
	Gas input		Injector	
				
	kW	g/hr	mm	
			Sabaf	Somipress
Gas burners	2 x 1.5 1 x 1.0	2 x 108 1 x 72	0.62 0.50	0.61 0.52
Electric hotplate	1 x 800W 230-240V ~ 50Hz			
Grill burner	1.6	115	0.62	0.62
Total	5.6 (gas) 800W (electric)	403		

**Table 2: Dimensions and weight**

Dimensions	SHG720 series			SHG730 series		
	H	W	D	H	W	D
mm	311	513	500	311	513	500
Appliance weight	14.5kg			16.2kg		
Spark ignition	12V DC			12V DC		

**Table 3: Gas category**

EN

Class 3 Appliance	
CAT I <sub>3</sub> + (28-30/37)	CAT I <sub>3</sub> B/P (30)
BUTANE (G30) 28 – 30mbar	BUTANE (G30) 30mbar
PROPANE (G31) 37mbar	PROPANE (G31) 30mbar



Use only the type of gas and the pressures specified.

## 11. Servicing

All servicing must be carried out by an approved competent person. Before any service work is started, the appliance should have been left to cool and be disconnected from both the gas and electrical supplies. After each service the appliance must be checked for gas soundness and electrical safety.

For service, please contact your authorised local Service Centre giving details of the model and serial number on the data badge plus date of purchase.

Model Name & Series Number				
G30 G31	CAT I <sub>3</sub> +(28-30/37) BUTANE 28-30mbar PROPANE 37mbar	CAT I <sub>3</sub> B/P(30) BUTANE 30mbar PROPANE 30mbar	<b>THETFORD</b>	
ΣQn	Power kW (g/hr)	Model Number	Spark Ignition	
CE	Pin Number	Serial Number	Voltage ~ 50 Hz	
Country Codes 1		Country Codes 2	Power kW	
			QC Pass	Order No

## 12. Questions / customer service

- Visit [www.thetford.com](http://www.thetford.com).
- Contact Customer Service Thetford in your country. See the addresses on the back.

**EUROPEAN HEADQUARTERS**

Thetford B.V.  
Nijverheidsweg 29  
P.O. Box 169  
4870 AD Etten-Leur  
The Netherlands

T +31 76 504 22 00  
F +31 76 504 23 00  
E [info@thetford.eu](mailto:info@thetford.eu)

**UNITED KINGDOM**

Thetford Ltd.  
Unit 6  
Brookfields Way  
Manvers, Rotherham  
S63 5DL, England  
United Kingdom

T +44 844 997 1960  
F +44 844 997 1961  
E [info@thetford.eu](mailto:info@thetford.eu)

**GERMANY**

Thetford GmbH  
Schallbruch 14  
D-42781 Haan  
Deutschland

T +49 2129 94250  
F +49 2129 942525  
E [infod@thetford.eu](mailto:infod@thetford.eu)

**FRANCE**

Thetford S.A.R.L.  
Parc BUROPLUS / Bâtiment 6  
18, Boulevard de la Paix  
95800 CERGY  
France

T +33 1 30 37 58 23  
F +33 1 30 37 97 67  
E [info@thetford.eu](mailto:info@thetford.eu)

**ITALY**

Thetford Italy c/o Tecma s.r.l.  
Via Flaminia  
Loc. Castel delle Formiche  
05030 Otricoli (TR)  
Italia

T +39 0744 709071  
F +39 0744 719833  
E [info@thetford.eu](mailto:info@thetford.eu)

**SPAIN AND PORTUGAL**

Mercè Grau Solà  
Agente para España y Portugal  
c/ Castellet, 36 bxs 2º  
08800 Vilanova i la Geltrú  
Barcelona  
España

T +34 938 154 389  
F not available  
E [infosp@thetford.eu](mailto:infosp@thetford.eu)

**SCANDINAVIA**

Thetford B.V.  
Representative Office Scandinavia  
Hantverkaregatan 32D  
521 61 Stenstorp  
Sverige

T +46 31 336 35 80  
F +46 31 44 85 70  
E [infos@thetford.eu](mailto:infos@thetford.eu)

**AUSTRALIA**

Thetford Australia Pty. Ltd.  
41 Lara Way  
Campbellfield VIC 3061  
Australia

T +61 3 9358 0700  
F +61 3 9357 7060  
E [infoau@thetford.eu](mailto:infoau@thetford.eu)  
[www.thetford.com.au](http://www.thetford.com.au)

**CHINA**

Thetford China  
Rm. 1207, Coastal Building  
(East Block)  
Haide 3rd Road, Nanshan District  
Shenzen, 518054  
China

T +86 755 8627 1393  
F +86 755 8627 1673  
E [info@thetford.cn](mailto:info@thetford.cn)  
[www.thetford.cn](http://www.thetford.cn)